

WHOLE HOUSE EXTRACT UNITS

OZEO-E / OZEO-E Ecowatt

NEW



Whole house extract units ensuring permanent renewal of air in individual houses.

The unit is complemented with self-adjusting extraction BAR valves, installed in kitchen, toilets, bathrooms and self-regulated air inlets located in the main dining room and bedrooms.

Configuration

- Three-speed motor (with two adjustments for the Ecowatt model).
- 4 Ø 125 mm inlets, with built in sealing gasket. For bathrooms and toilets that can be dismantled, pivoting 90°.
- 1 Ø 125 mm outlet that enables used air to be extracted outside. This duct pivots 360°.
- 1 radio frequency remote control (Ecowatt Model).
- 3 caps to seal unused inlets.
- 1 template to facilitate fitting on the ceiling or wall.

**ENERGY
EFFICIENT**



**VENTILATION
SYSTEM**

A P P L I C A T I O N S



Attic or closet installations

A L T E R N A T I V E F I T T I N G

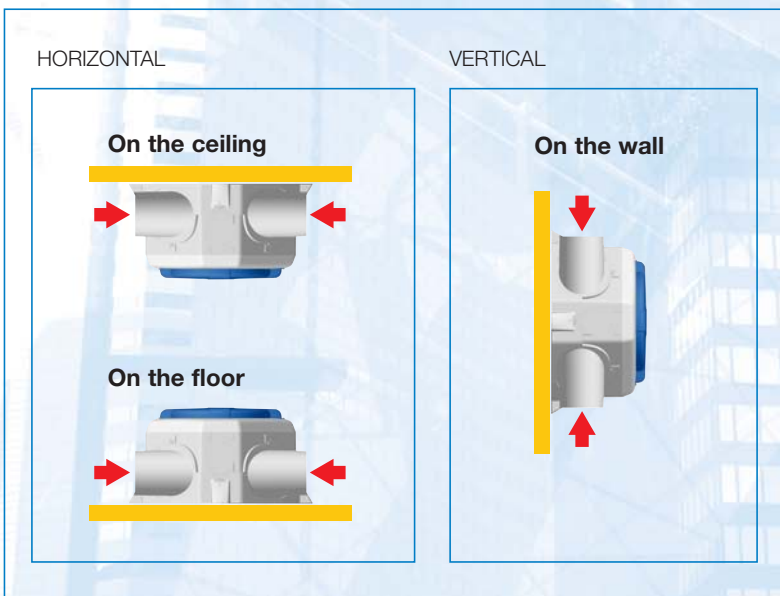

F L E X I B I L I T Y

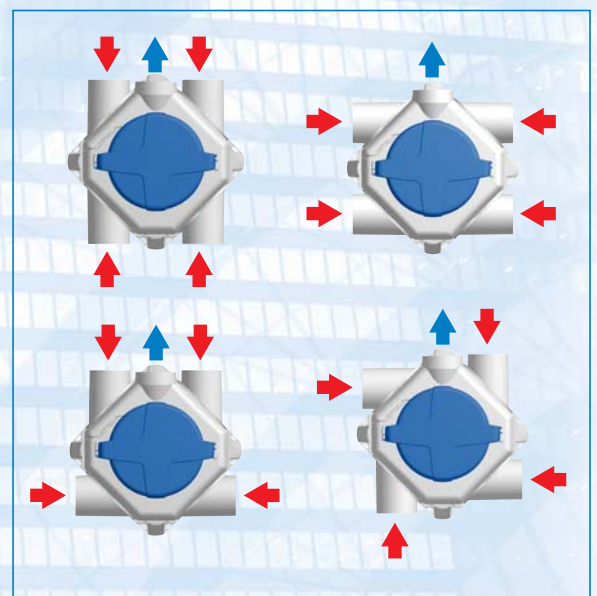

Technical characteristics

Model	Motor	Voltage (V)	Maximum absorbed power (W)	Maximum absorbed current (A)	Sound power dB (A)
OZEO-E	AC	230	20 - 39 - 56	0,19 - 0,24 - 0,23	33-35-38
OZEO-E Ecowatt	DC	230	15,5 - 25 - 48	0,15 - 0,23 - 0,4	30-35-38

Performance curves

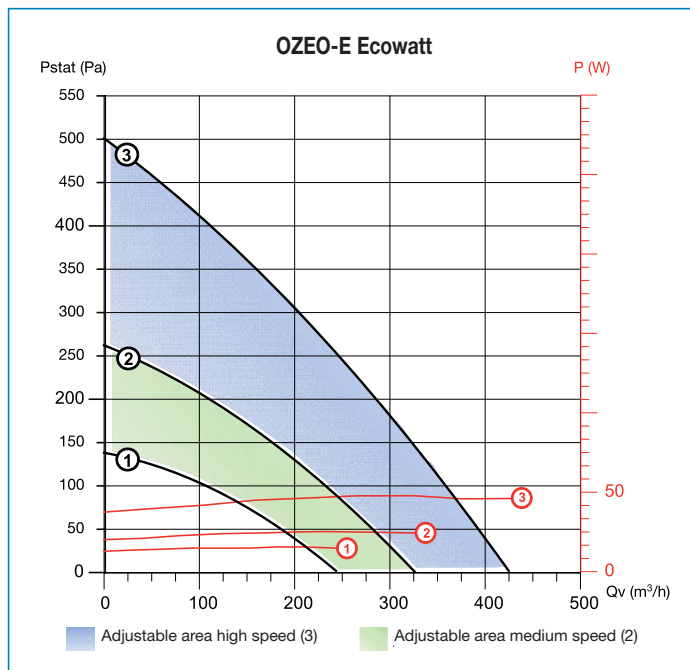
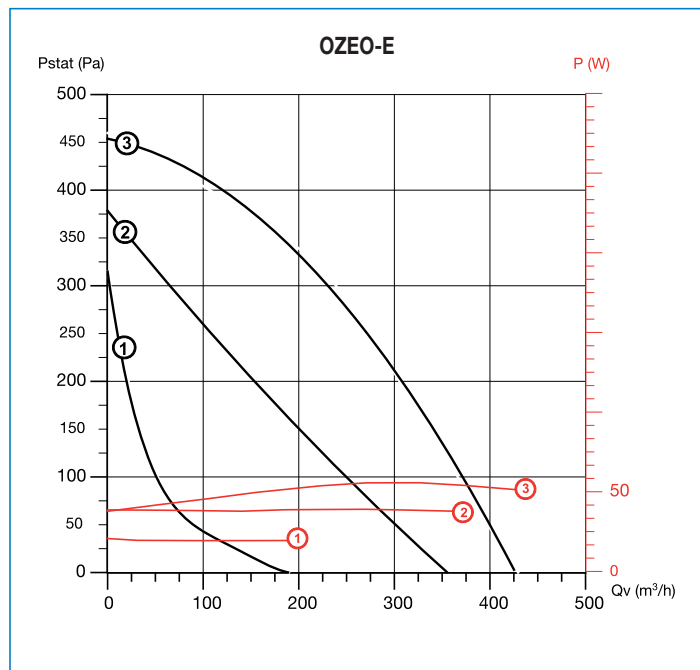

Dimensions (mm)

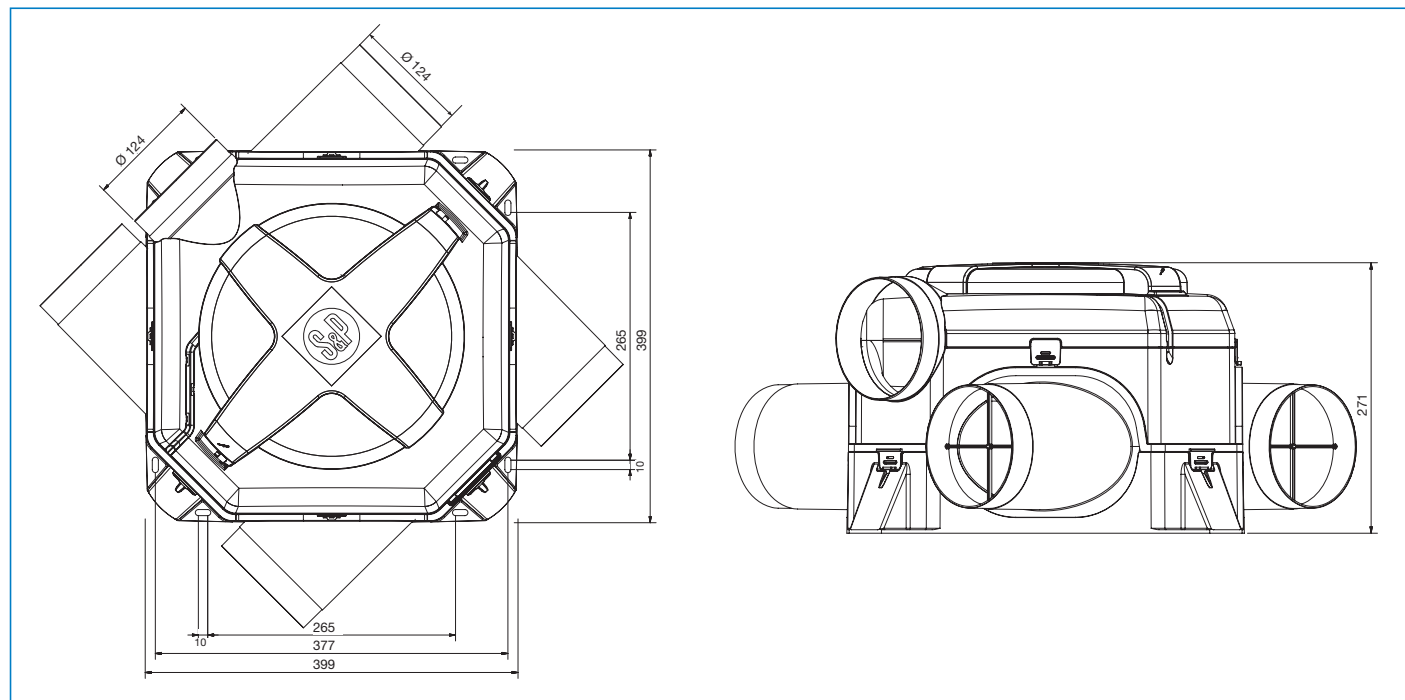

OZEO-E / OZEO-E ECOWATT

Centralized self-adjusting

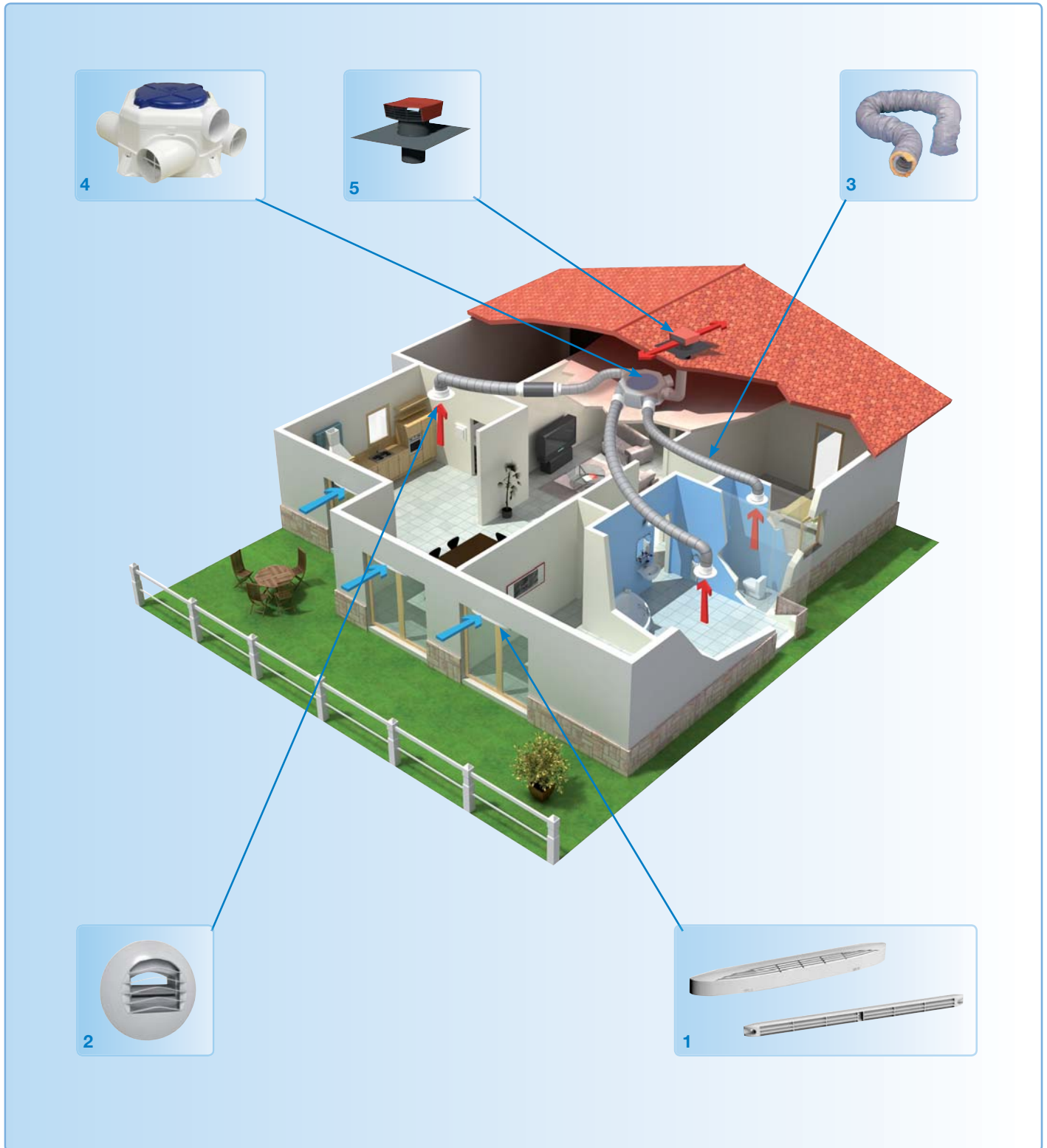

1. Self-adjusting acoustic air inlets ECA
2. Self-adjusting exhaust valves BAR

3. Flexible ducting GP
4. Whole house extract units OZEO-E / OZEO-E ECOWATT

5. Roof terminal cowl CT

■ **Accessories**



ALIZE BAR
Self-adjusting
exhaust valves.



EC and ECA
Standard and
acoustic,
self-adjusting
air inlets.



GP/GP Iso
PVC flexible ducts.
Ø 80 and 125.

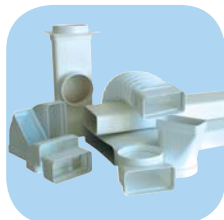

Tub Pla
Rectangular ducts
made of
self-extinguishing
plastic.
55 x 220 mm and
55 x 110 mm.

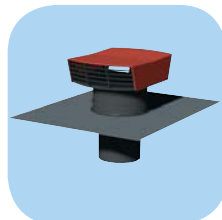

CT
Roof cap.



PAF
Circular discharge
grille on the wall
with a Ø 125 mm
connection.

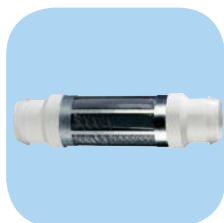

LA
Silencer 125 mm.

■ **Control accessories**



3-velocity switch for
OZEO-E
(cable connection).

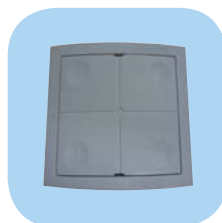

Remote control (wireless) for
OZEO-E ECOWATT
(1 unit within the scope of supply).